

Installation Instructions

EUTRAC DALI
the intelligent track™

2~/120V

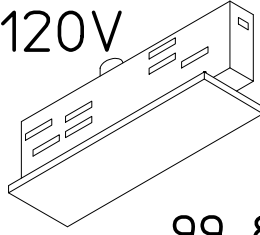

99-818-.

Mid Feed with
Bus contact

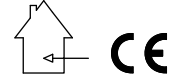

INSTALLATION INSTRUCTIONS

- READ ALL OF THESE INSTALLATION INSTRUCTIONS BEFORE INSTALLING THE EUTRAC TRACK SYSTEM.
- SAVE THESE INSTRUCTIONS AND REFER TO THEM WHEN ADDITIONS TO OR CHANGES IN THE TRACK CONFIGURATION ARE MADE.
- Fitting is only to be used with EUTRAC series 233 track system.
- To be installed by trained personnel only.
- It is the responsibility of the installer to ensure the electrical, mechanical and thermal compatibility of the track system and the fittings.
- Materials used for ceiling fixation should conform to relevant building regulations.
- It is essential to cover the ends of the track with end covers or protective caps.
- This track system is not intended for use with a power supply cord or convenience receptacle adaptor.
- This track system is to be supplied by a single branch circuit.
- Track is not to be mounted by cables.

IMPORTANT SAFETY INSTRUCTIONS

- READ ALL INSTRUCTIONS.
- Do not install this track in damp or wet locations.
- Unless provision for field cutting, do not cut any track sections.
- Do not install any part of a track system less than 5 ft. above the floor.
- Do not install any fixture assembly closer than 6 inches from any curtain or similar combustible material.
- Disconnect electrical power before adding to or changing the configuration of the track.
- Do not attempt to energize anything other than lighting track fixtures on the track. To reduce the risk of fire and electrical shock, do not attempt to connect power tools, extension cords, appliances, and the like to the track.
- (For track lighting systems other than 120V, two-wire) Do not connect the track to more than one branch circuit unless the track is constructed so that it can be used with more than one branch circuit. Check with a qualified electrician. Although the track lighting system may seem to operate acceptably, a dangerous overload of the neutral may occur and result in a risk of fire.
- SAVE THESE INSTRUCTIONS.

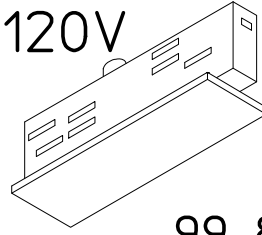

99-818-.

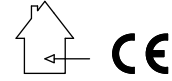

- The Mid Feed can be installed in any position on surface-mounted track.

- Drill hole for feed point provided on side.

- After drilling do remove burrs.

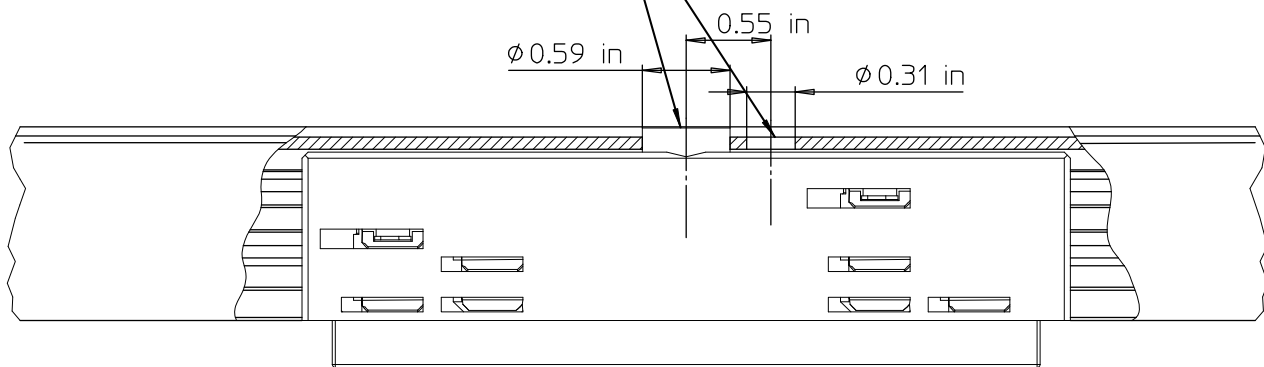

②

-Mount the the Mid Feed Canopy .

Article number -198 60 0001

④

-Slide the canopy so that the bracket cutout covers around the 0.59 in drilled hole.

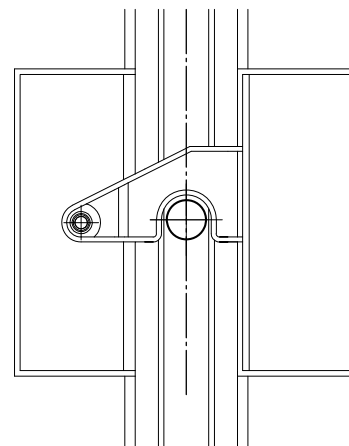
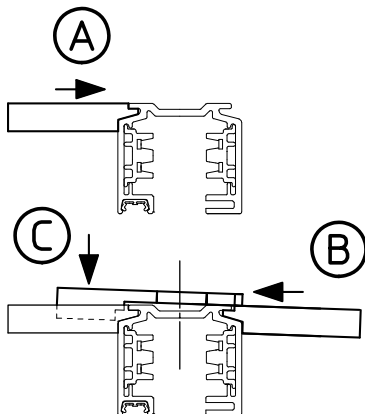

Installation Instructions

EUTRAC | DALI

the intelligent track™

2~/120V

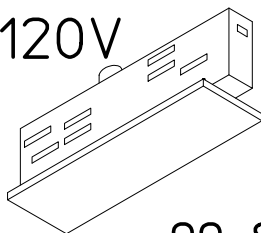

99-818-.

Mid Feed with
Bus contact



③

-Feed the power line wires through the track.

-Concurrently mount the track by referring the Instructions provided with the track.

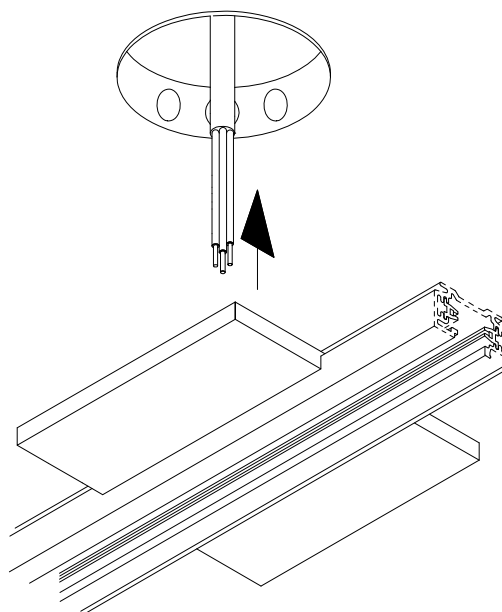
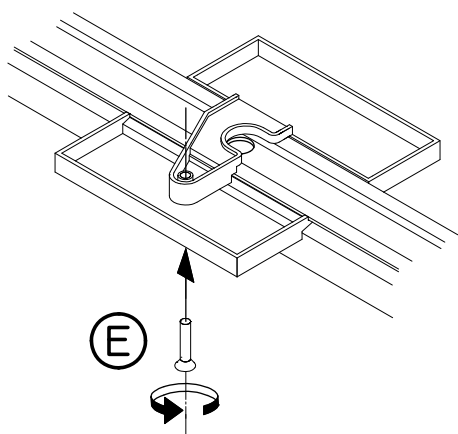

④

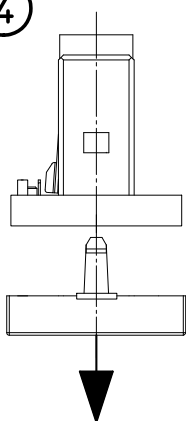

Before mounting, press in the catch using a screw driver and remove the cover.

⑤

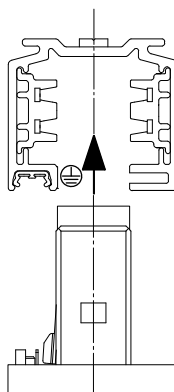

Having removed the cover, insert the mid feed into the track at the prepared position.

Note :

The EUTRAC mid feed only fits into the EUTRAC-Track 233...

⑥

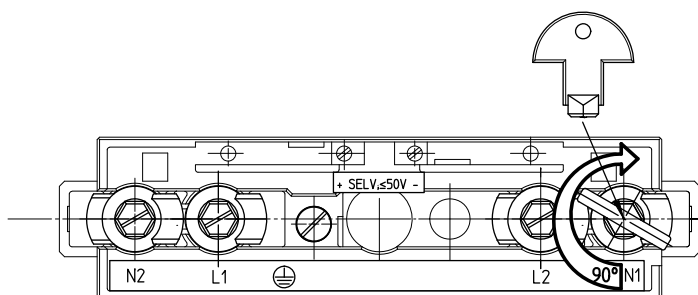

Mechanical Installation:

Using the enclosed hexagonal head spanner, turn all contact screws in the direction indicated by the arrow.

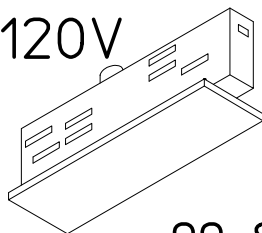

7

CONNECTING

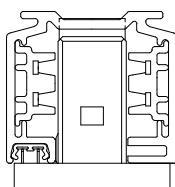

When the mid feed has been fixed securely into place, the individual circuits and the earth conductor can be wired as shown.

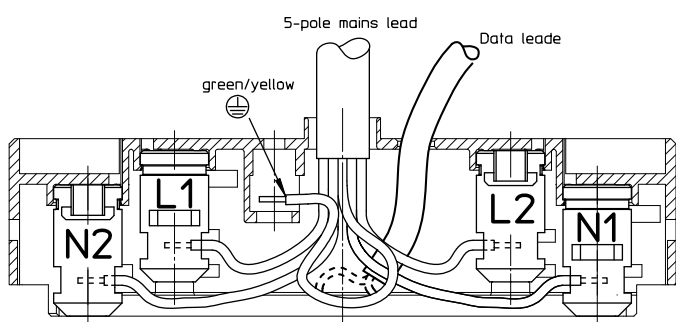

When wiring the track, check that the earth conductor (green/yellow) and the neutral conductor (blue) are connected, as indicated in the illustration.

Circuits 1 and 2 can be wired as required.

Strip the insulation
on the mains lead :

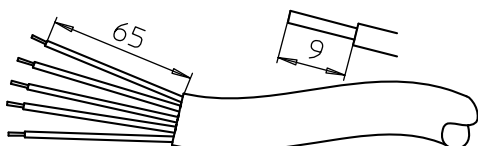

Strip the insulation
on the data lead :

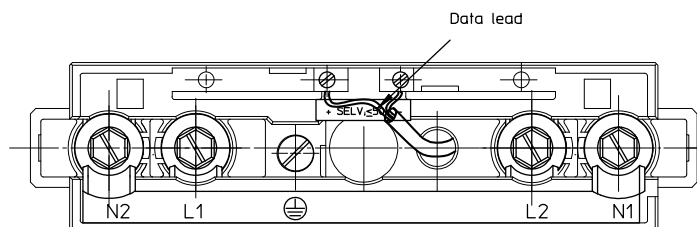
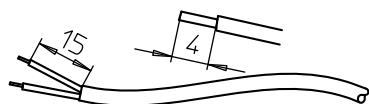

Installation Instructions

EUTRAC | DALI

the intelligent track™

2~/120V

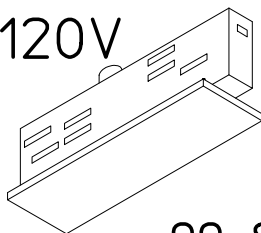

99-818-.

Mid Feed with
Bus contact



8

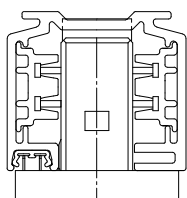

When the wiring is complete,
replace the cover and clip
into place.

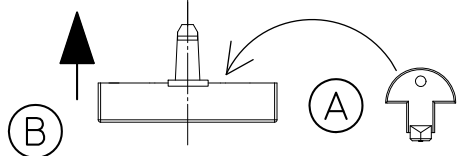

~ 120V

$P_{max.} = 5.540VA$

— = 2 x 20A

∅_{min.} = 3 x AWG 12

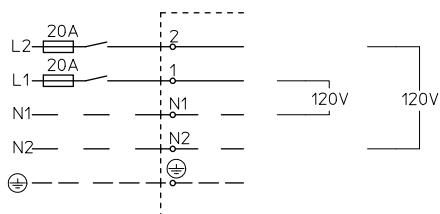

- Standard DALI control systems may only be used if they fulfil SELV (Safety-Extra-Low-Voltage) requirements.

If not use a SELV safety component.

Data line (maximum) 2 x AWG 18

EUTRAC / DALI control system permissible

ATTENTION:

Data lead max. 20V 250 mA